

STJ-3D: 3-Axis Magnetic Sensor

Description

Micro Magnetics' STJ-3D is an integrated 3-axis magnetic solid-state sensor used to measure absolute magnetic field vectors with three field components along the X-, Y-, and Z-axis. Based on the state-of-the-art technology of magnetic quantum mechanical tunneling junction (MTJ), the sensor is featured with high sensitivity, large dynamic range, low signal noise, and low power consumption. STJ-3D is easy to use, requiring only an applied voltage (up to 24V). It outputs three corresponding voltages for 3-axis magnetic field components. There is no need to regularly apply a large current pulse to cure the magnetic structure disordered by field sensing, as needed by other types of sensors. The internal magnetic structure of STJ-3D is robust against even Tesla-scale external field, remaining operational as a fresh sensor after extensive use.

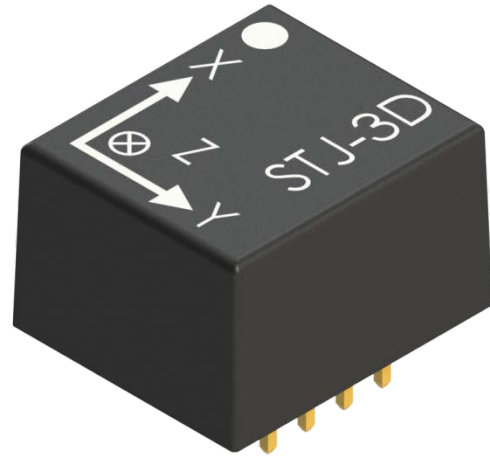

STJ-3D operates in a wide frequency range between DC to about 7 MHz. The applied voltage can be either DC or AC. Electronic noise can be minimized by using AC modulation on the applied voltage.

Furthermore, STJ-3D has a built-in thermistor, allowing the measurement of both temperature and magnetic field to be measured simultaneously.

Micro Magnetics' STJ-3D is ideally suited a wide range of applications.

Features

- Small physical package: (L x W x H) 15 x 17.4 x 10.5 mm (0.591 x 0.685 x 0.413 inch)
- Ultralow field noise: 10 nT or 0.0001 Gauss
- Large magnetic field dynamic range: ± 20 Gauss
- High sensitivity: 1-4 mV/V/Gauss
- Frequency range of magnetic field: DC to 7 MHz
- Sensor resistance: > 2000 Ohm per axis (Typical)
- Absolute field measurement
- Operation: up to 24.0 VDC or VAC
- Built-in temperature sensor
- High field direction accuracy
- Low power consumption
- No need for magnetic reset pulse circuit
- Analog and bipolar magnetic field sensor

Applications

- Ultrasensitive magnetic field sensing
- Static and dynamic measurement of magnetic field
- Detection of sub-surface magnetic activities
- Electronic compass and navigation
- Non-contact sensing of electrical current
- Smart grid diagnostics
- Medical devices
- Spatial mapping of magnetic field
- Measurement of magnetic spectrum from devices and environment
- Measurement of earth and geo-magnetic field

STJ-3D: Specifications

PHYSICAL	Min.	Typical	Max.	Unit
Length		17.4		mm
Width		15		mm
Height		10.5		mm
Height including pins		14		mm
ELECTRICAL				
Sensor Resistance per Axis	400	1000	200000	Ω
Operating Voltage (V_+ to V_-), V Supply	0.5	5	24	V
Maximum Operating Frequency	1	5	10	MHz
MAGNETIC				
Total Magnetoresistance (MR)	50	80	200	%
Magnetic Field Sensitivity per Axis (at 5V, +/-5G)	1	2	4	mV/V/G
Zero Field Voltage Offset Relative to V Supply	40	50	60	%
Hysteresis ⁵ (field range = +/- 5G)	1	4	10	%
Equivalent Field Noise (100 Hz)	2	5	15	nT/Hz ^{0.5}
Equivalent Field Noise (10 kHz)	0.2	1	5	nT/Hz ^{0.5}
THERMAL				
Operating Temperature	-50		80	C
Temperature Coefficients (see page 5)				

Note: Magnetic Field Units and Conversion 1 G(Gauss) = 1 Oe, 1 T(Tesla) = 10,000 G

STJ-3D: Physical Dimensions and Magnetic Field Directions

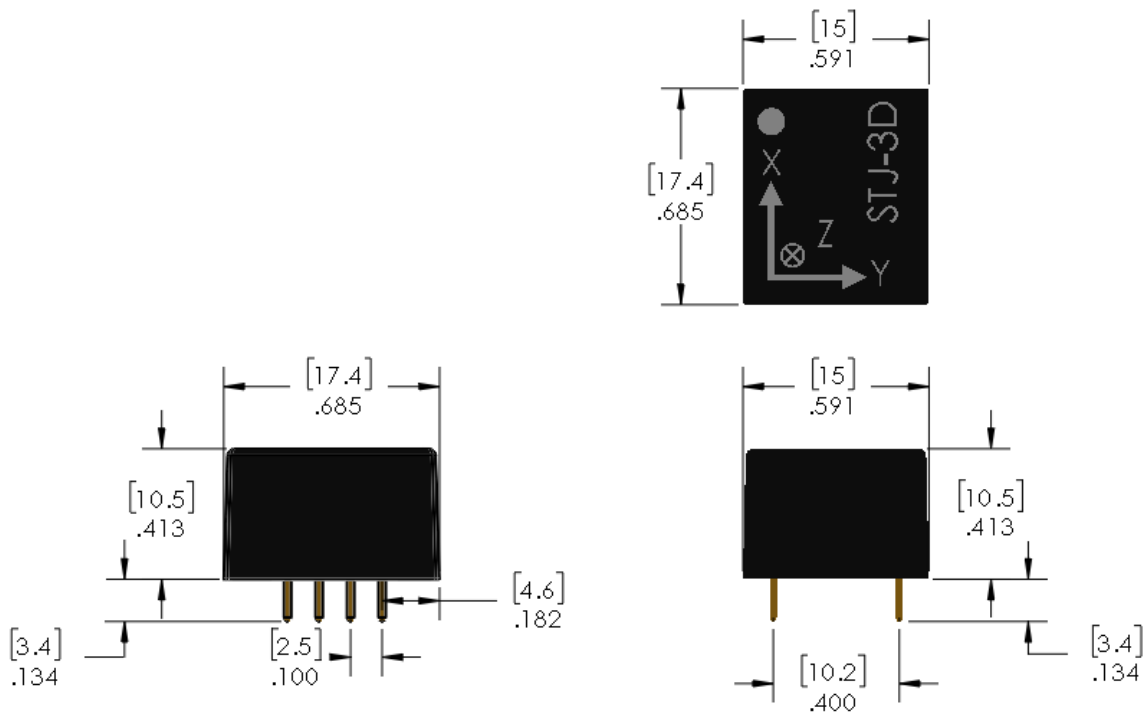

Units: inches [mm]

STJ-3D: Positions of Magnetic Sensors for X-Axis, Y-Axis, and Z-Axis

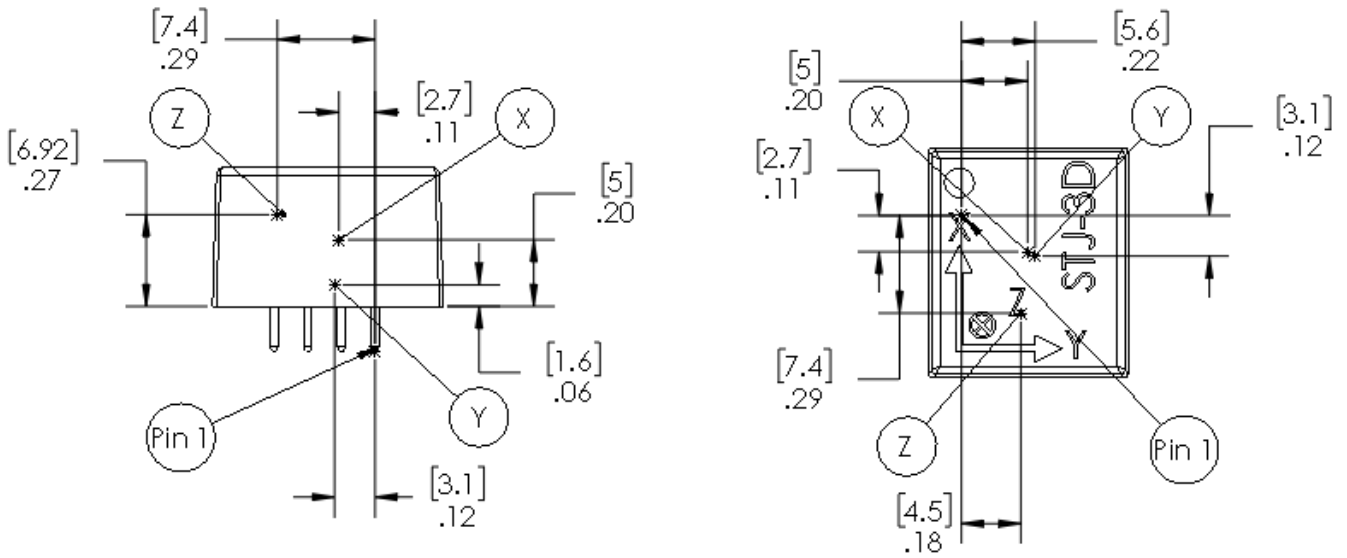

STJ-3D: PCB Foot Print

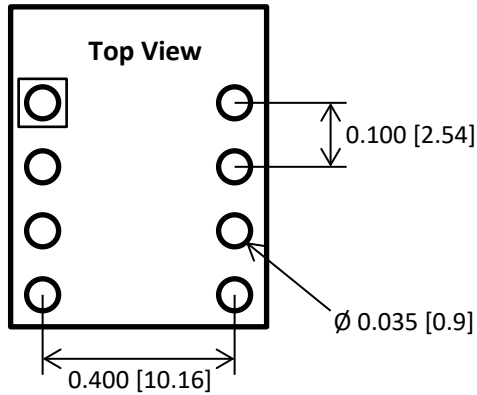

STJ-3D: Pin-out and Description

Pin #	Name	Pin #	Name
1	V+	5	V-
2	Vx	6	RT1
3	Vy	7	RT2
4	Vz	8	NC

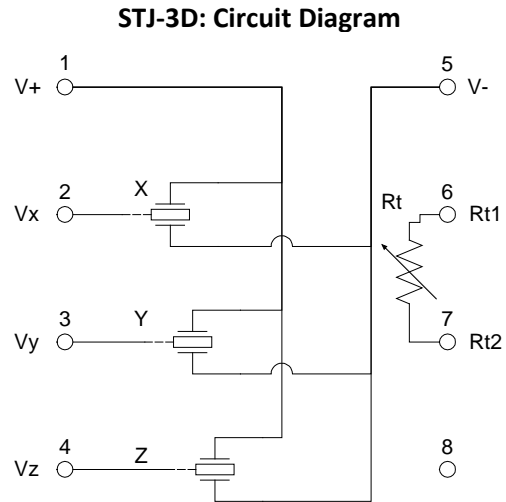

- Pin 1, 5 (V₊, V₋): V Supply. Single Supply (V₊ = 0.5 – 24V, V₋ = 0V) or Dual Supply (+/- 0.25 to +/- 12V). Recommended V₊ = 5V, V₋ = 0V. Polarity can be either positive or negative, or AC. Do not exceed maximum voltage of 24V.
- Pin 2, 3, 4 (V_x, V_y, V_z): Signal outputs corresponding to x-, y-, z-components of magnetic field vector. At zero field, V_x, V_y, V_z outputs V_{dd}/2 (50% of V_{dd}), approximately. The actual outputs at zero field are provided by the calibration curves. The polarities of V_x, V_y, V_z are the same as V_{supply}.

Signal Output = Zero Field Offset + Sensitivity * VSupply * Magnetic Field(Oe)

$$\text{Zero Field Offset} = \frac{V_{\text{supply}}}{2} \pm 10\% \quad \text{Sensitivity} = \text{mV}/V_{\text{supply}}/\text{Oe}$$

- Pin 6, 7 (RT1, RT2): The two connectors are used to measure the resistance of the temperature sensor (thermistor). The operation of the thermistor is described in the “Temperature Sensor” section.

STJ-3D: Magnetic Sensor Thermal Data (Typical)

Temperature Coefficient of Resistance

$$TCR = (1/R)(\Delta R/\Delta T)$$

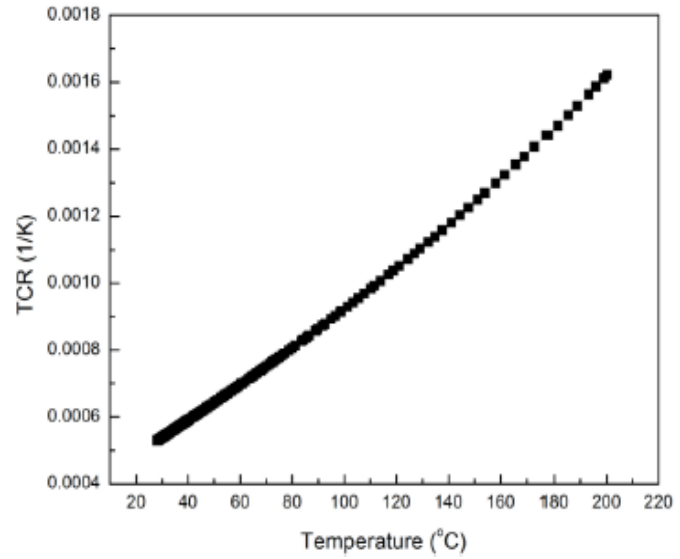

Temperature Coefficient of Sensitivity

$$TCS = (1/S)(\Delta S/\Delta T)$$

Sensitivity (S) is the “Magnetic Field Sensitivity” parameter in the Specifications.

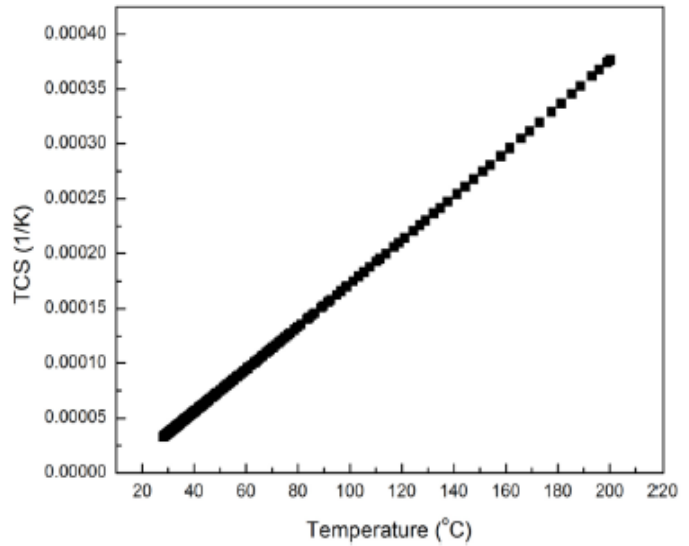

NTC Thermistor Temperature Sensor

The temperature sensor used in STJ-3D is an SMD NTC thermistor, whose resistance varies with temperature. The figures below show the resistance value of the thermistor versus temperature in linear and log₁₀ scales. The thermistor features:

- Temperature measurement range: -55-150 °C
- High accuracy: ± 5 % in resistance
- Excellent long-term ageing stability in high-temperature and high-humidity environment (up to 93%)
- B25/50 = 4250, B25/85 = 4300
- Thermal cooling time constant of about 10 sec
- Resistance = 10,000 Ohm at 25 °C

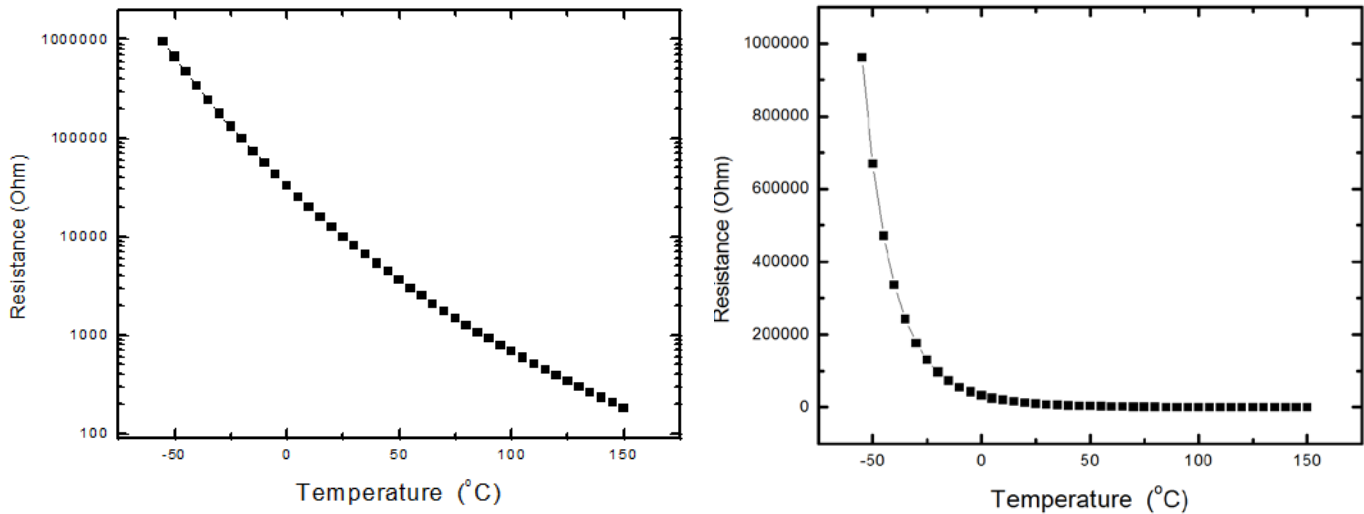

To determine the temperature (T in the units of Celsius °C), measure the resistance (R in the units of Ohm) of the thermistor. Then calculate the temperature using the following formula,

$$T (^{\circ}C) = \frac{4250}{\ln\left(\frac{R}{0.02165}\right)} - 273.15$$

STJ-3D: Precautions and Handling Instructions

1. MTJ sensors will fail if subjected to a sufficiently large differential voltage. Do not exceed 24 V.
2. Please store sensors as they were shipped and in a location which is away from sources of radiated electromagnetic fields (ESD/EMI).
3. Sensors are sensitive to electrostatic discharge (ESD). Be careful to ground tools and your hands when handling the sensors. If possible, be sure to wear grounding straps when handling the sensors.